

PH-T36N

Datasheet

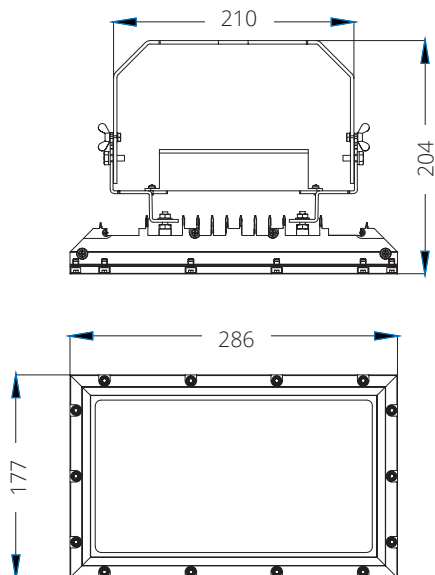

Dimensions [mm] and weight



Net weight	3.5 kg
Gross weight	4.0 kg
Carton size	360 × 250 × 210 mm

Structure and material

Housing	high-pressure die-cast aluminium
Cover	flat glass, tempered at 200°C
Luminaire ingress protection code	IP67
Driver ingress protection code	IP67
Impact protection code	glass IK08, housing IK10

Electrical

Input voltage and frequency	100-240 V, 50/60 Hz
Protection class IEC	Class I
Rated power	36 W
Power factor	> 0.96
Other options available	<ul style="list-style-type: none"> • Protection class II • Additional power supply cable • Dimming schedule • CLO (Constant Light Output) activation • Surge protection

Performance

Rated luminous flux (estimated)	3600 lm
Rated efficiency	85-95%
Rated colour rendering index and correlated colour temperature	<ul style="list-style-type: none"> • >70 at 4000-5700 K • >80 at 3000-3500 K • >90 at 2700 K
Useful life	70,000 hours at 25°C ambient temperature

Installation and operational conditions

Pole diameter	42-60 mm
Adjustable tilting angle	-90°, 0° and 90°
Recommended mounting height	8-20 m
Ambient temperature	-40°C to +50°C
Storage temperature	up to +80°C
Humidity	5-95 %
Wind area	0,047 sq.m.

Applications

Sports facilities, car parks, building facades, tunnels, area illumination, architecture lighting, gas stations, industrial facilities, commercial lighting etc.



PH-T36N

Installation guide

Prior to performing the installation, please carefully read the below information and follow all safety instructions.

Warning and caution

- Cut off power before the installation. Risk of electric shock.
- All servicing should be performed by qualified personnel only.
- To avoid electrical overload, total connected lamp load (factory and field installed) should not exceed output rating
- Shut off AC power to branch circuits to which units will be connected. All wiring should be per N.E.C. Articles 501-4(b) and local codes.
- Equipment should be mounted in locations and at heights where it will not be readily subjected to tampering by unauthorized personnel.
- The use of any accessory equipment not provided by the manufacturer is not recommended as it may cause unsafe conditions.
- Do not use this equipment for other than intended use.
- Do not let supply cords come in contact with hot surfaces.
- Do not mount near gas or electric heaters.

Pole or arm mounting

Use appropriate U-bolt and thrust bearing (sold separately) for pole or arm mounting

Required tools

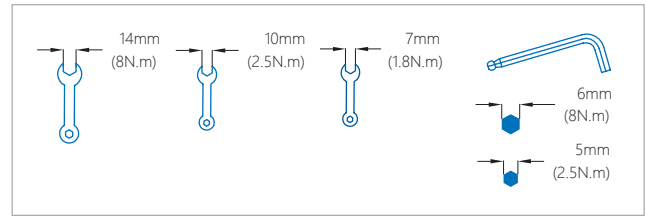

Surface mounting

Surface mounting with thrust bearing (sold separately)

Surface mounting without thrust bearing (sold separately)

Power line connection

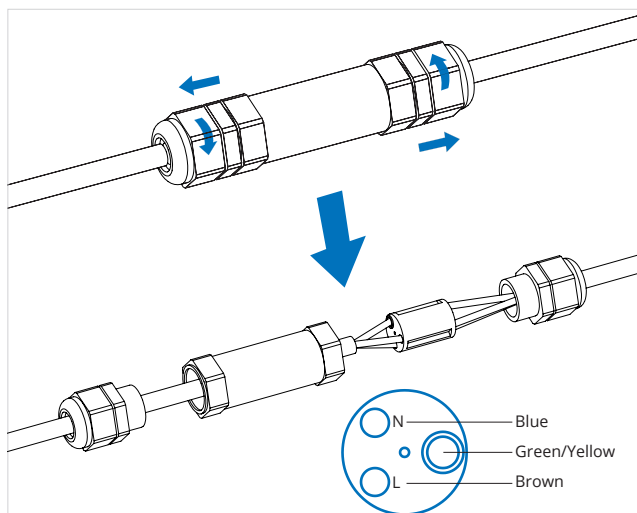

1. Release the nuts on the waterproof case and take the connecting terminal out.
2. Use a slotted screwdriver to release the screws and respectively connect the N null line (blue wire), L live line (brown wire) and grounding line (yellow/green wire). Lock the screws.
3. Put the connection terminal into waterproof case and fasten the nuts.